

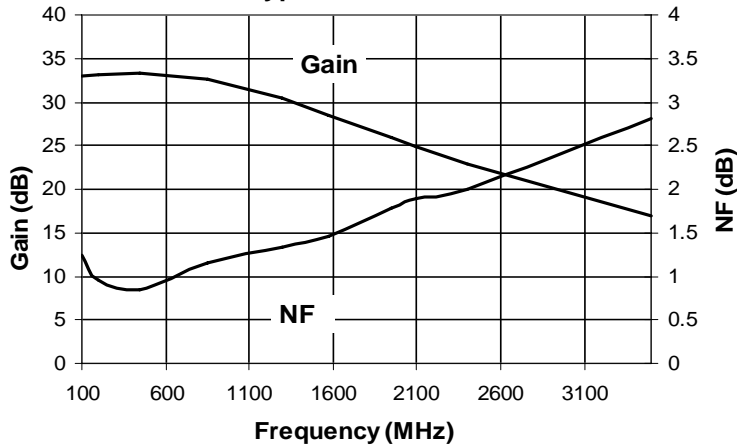

Product Description

The SGL-0622Z is a low noise, high gain MMIC LNA designed for low power single-supply operation from 2.7-3.6V. Its Class-1C ESD protection and high input overdrive capability ensures rugged performance, while its integrated active bias circuit maintains robust stable bias over temperature and process beta variation. The SGL-0622Z is internally matched from 5-4000 MHz and requires only 4-5 external biasing components (DC blocks, bypass caps, inductive choke). The SGL-0622Z is fabricated using highly repeatable Silicon Germanium technology and is housed in a cost-effective RoHS/WEEE compliant QFN 2x2 miniature package.

Typical Performance



SGL-0622Z

5 - 4000 MHz Low Noise MMIC Amplifier Silicon Germanium

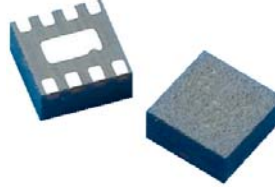

Product Features

- High Gain = 28dB @ 1575MHz
- Low Noise Figure = 1.5dB @ 1575MHz
- Low Power Consumption, 10.5mA @ 3.3V
- Battery Operation: 2.7-3.6V (Active Biased)
- Fully Integrated Matching
- Class-1C ESD Protection (>1000V HBM)
- High input overdrive capability, +18dBm
- RoHS/WEEE Compliant Miniature 2x2 QFN Package

Applications

- High Gain GPS Receivers
- ISM & WiMAX LNAs

Symbol	Parameters	Units	Frequency	Min.	Typ.	Max.
S ₂₁	Small Signal Gain	dB	1.575 GHz	25	28	31
			2.44 GHz		23	
			3.5 GHz	14.5	16.5	18.5
NF	Noise Figure	dB	1.575 GHz		1.5	1.9
			2.44 GHz		2	
			3.5 GHz		2.8	
P _{1dB}	Output Power at 1dB Compression	dBm	1.575 GHz	3.3	5.3	
			2.44 GHz		1.5	
			3.5 GHz		-1.4	
IIP ₃	Input Third Order Intercept Point	dBm	1.575 GHz	-16	-13	
			2.44 GHz		-12	
			3.5 GHz		-8.5	
IRL	Input Return Loss	dB	1.575 GHz	12	14.3	
			2.44 GHz		12.0	
			3.5 GHz		10.0	
ORL	Output Return Loss	dB	1.575 GHz	6	9.5	
			2.44 GHz		14.0	
			3.5 GHz		22.0	
S ₁₂	Reverse Isolation	dB	0.05 - 4 GHz		-28	
I _D	Operating Current	mA		7.5	10.5	12.5
R _{TH, j-l}	Thermal Resistance (junction - lead)	°C/W			150	

Test Conditions: V_{CC} = 3.3V I_D = 10.5mA Typ. IIP₃ Tone Spacing = 1MHz, P_{out} per tone = -15 dBm
 T_L = 25°C Z_S = Z_L = 50 Ohms

The information provided herein is believed to be reliable at press time. Sirenza Microdevices assumes no responsibility for inaccuracies or omissions. Sirenza Microdevices assumes no responsibility for the use of this information, and all such information shall be entirely at the user's own risk. Prices and specifications are subject to change without notice. No patent rights or licenses to any of the circuits described herein are implied or granted to any third party. Sirenza Microdevices does not authorize or warrant any Sirenza Microdevices product for use in life-support devices and/or systems. Copyright 2007 Sirenza Microdevices, Inc.. All worldwide rights reserved.

Typical RF Performance at Key Operating Frequencies (With Application Circuit)

Symbol	Parameter	Unit	Frequency (MHz)							
			100	200	450	850	1575	1950	2440	3500
S ₂₁	Small Signal Gain	dB	34.6	34.9	34.4	32.8	28.5	26.1	23.0	17.0
IIP ₃	Input Third Order Intercept Point	dBm					-13.0		-12.0	-8.5
P _{1dB}	Output at 1dB Compression	dBm					5.3		1.5	-1.4
S ₁₁	Input Return Loss	dB	15.1	20.0	12.6	16.0	14.3	12.8	12.0	10.0
S ₂₂	Output Return Loss	dB	9.2	12.2	11.8	10.4	9.5	12.1	14.0	22.0
S ₁₂	Reverse Isolation	dB	38.8	39.8	38.7	39.9	35.6	34.8	32.0	29.0
NF	Noise Figure	dB	1.25	0.96	0.84	1.16	1.50	1.78	2.01	2.81

Test Conditions: V_{CC} = 3.3V I_D = 10.5 mA Typ. IIP₃ Tone Spacing = 1MHz, P_{out} per tone = -15 dBm
T_L = 25°C Z_S = Z_L = 50 Ohms

Absolute Maximum Ratings

Reliability & Qualification Information		Parameter		Absolute Limit	
Parameter	Rating	Parameter	Absolute Limit	Parameter	Absolute Limit
ESD Rating - Human Body Model (HBM)	Class 1C	Max Device Current (I _D)	20mA	Max Device Voltage (V _D)	4 V
Moisture Sensitivity Level	MSL 1	Max. RF Input Power* (See Note)	+18 dBm	Max. Junction Temp. (T _J)	+150°C
This product qualification report can be downloaded at www.sirenza.com		Operating Temp. Range (T _L)	-40°C to +85°C	Max. Storage Temp.	+150°C

***Note:** Load condition 1, Z_L = 50 Ohms
Load condition 2, Z_L = 10:1 VSWR
Operation of this device beyond any one of these limits may cause permanent damage. For reliable continuous operation, the device voltage and current must not exceed the maximum operating values specified in the table on page one.
Bias Conditions should also satisfy the following expression:
 $I_D V_D < (T_J - T_L) / R_{TH, j-l} \quad T_L = T_{LEAD}$



Caution: ESD sensitive

Appropriate precautions in handling, packaging and testing devices must be observed.

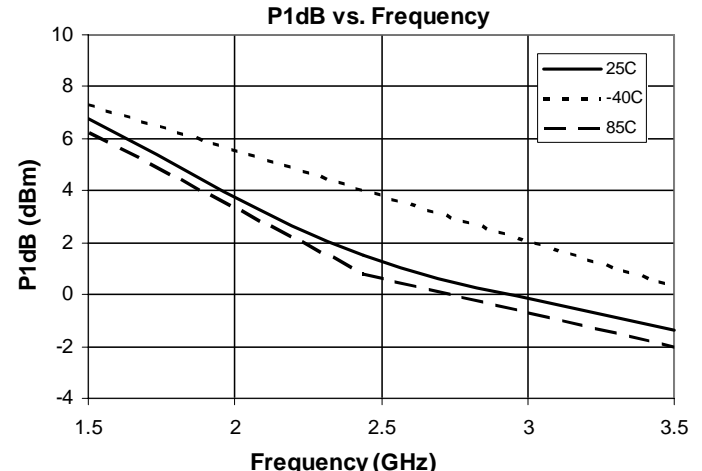
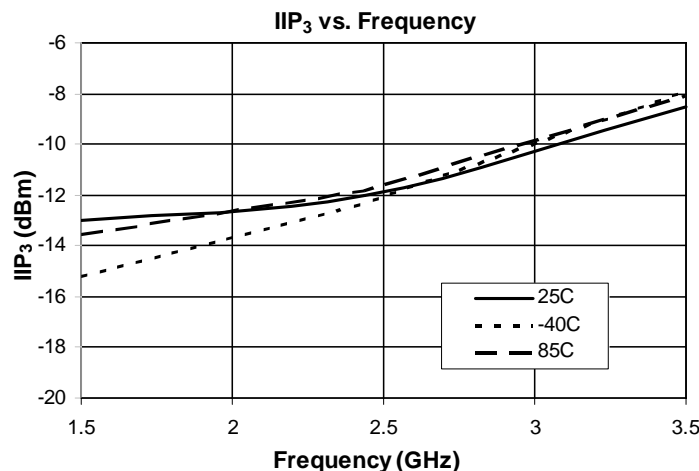
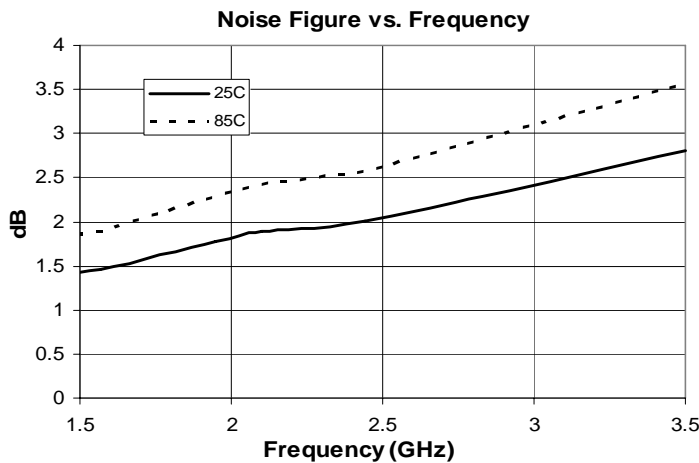

Application Circuit Data, $V_{CC} = 3.3V$, $I_D = 9mA$

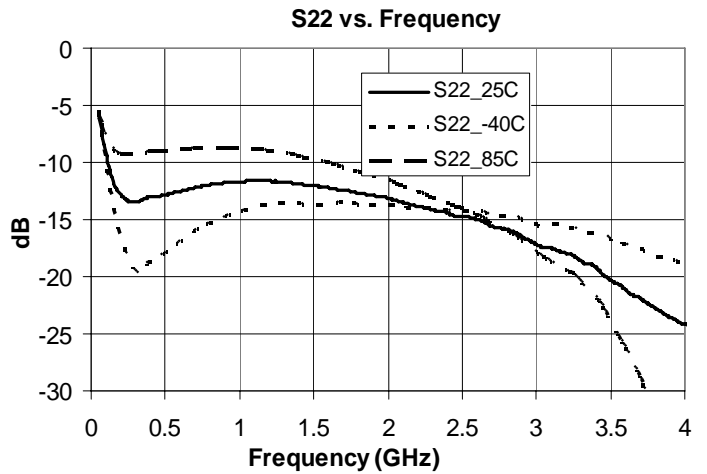
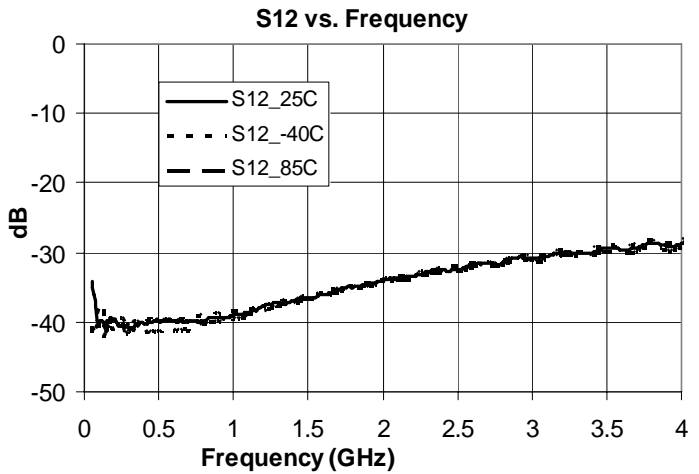
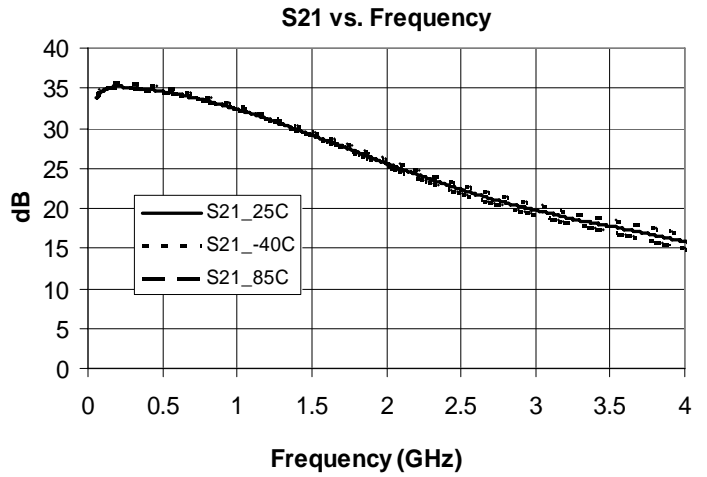
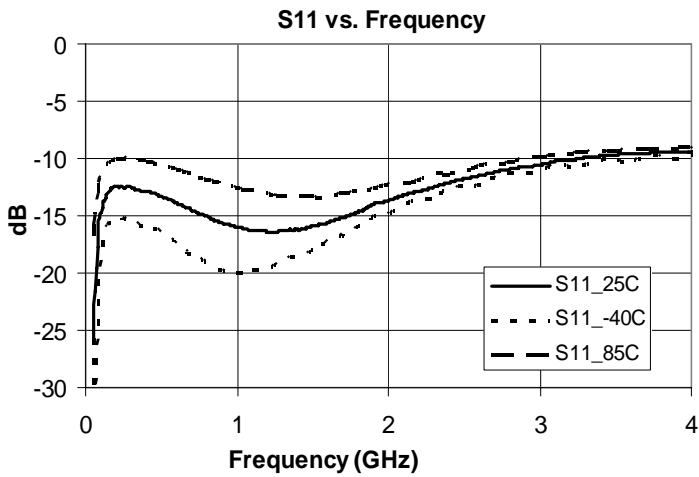
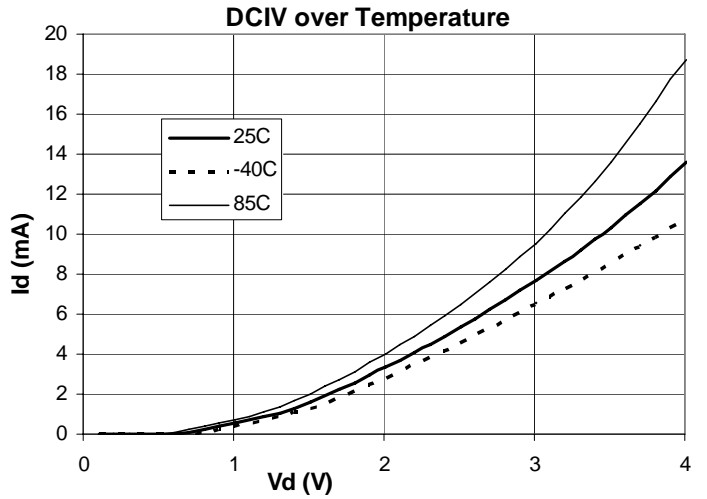
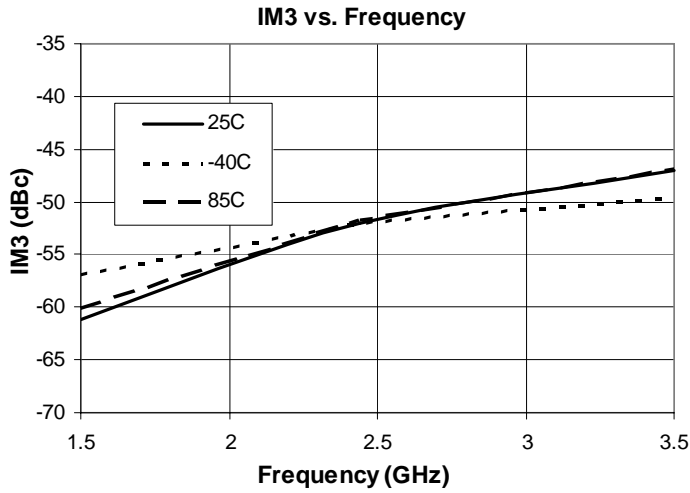

Application Schematic

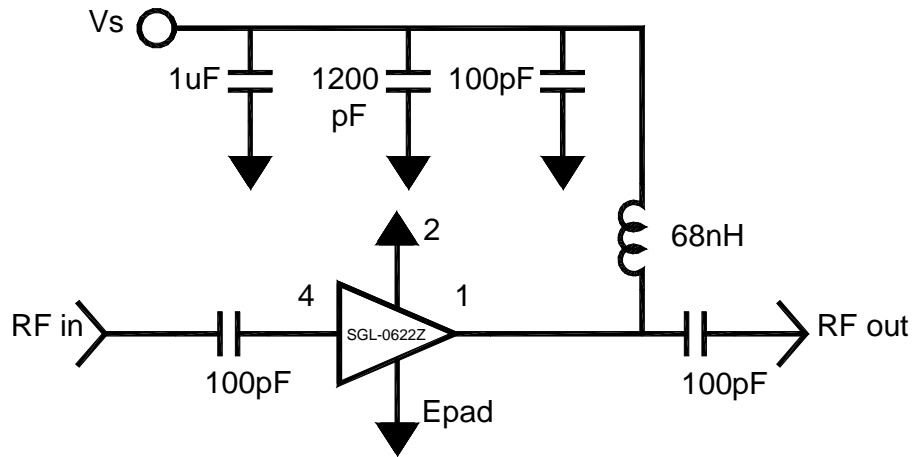

Evaluation Board Layout

Bill of Materials

- C1 1x TAJB105KLRH Rohm 1.0uF
- C2 1x MCH185C122KK Rohm 1200pF
- C3 1x MCH185A101JK Rohm 100pF
- C4 1x MCH185A101JK Rohm 100pF
- C5 1x MCH185A101JK Rohm 100pF
- L1 1x LL1608-FS56NJ Toko 68nH
- Connectors 2x PSF-S01-1mm GigaLane Co.
- Heat sink EEF-102059
- PCB QFN2x2

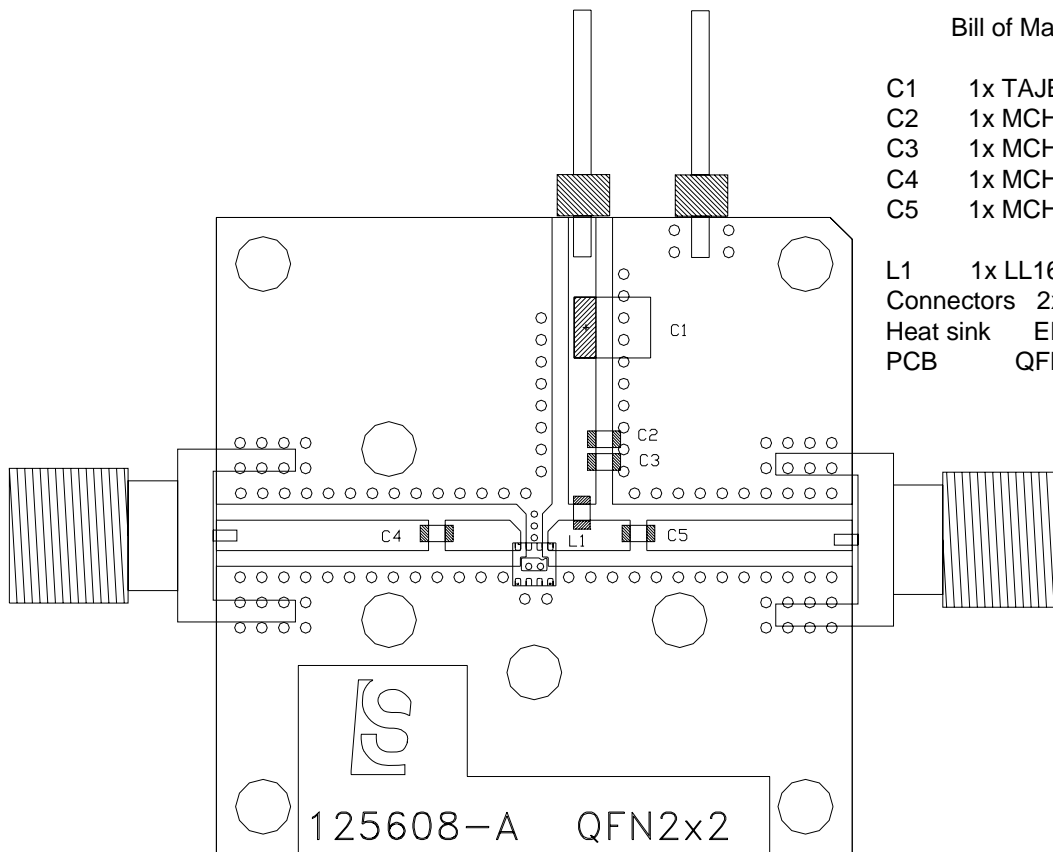

Pin #	Function	Description
1	RF OUT/V _D	RF output and bias pin. Bias should be supplied to this pin through an external RF choke. (See application circuit)
2	GND	Connect to ground per application circuit drawing.
3,5,6,7,8	N/A	Not Used
4	RF IN	RF input pin. This pin requires the use of an external DC blocking capacitor as shown in the application schematics.
EPAD	GND	Exposed area on the bottom side of the package needs to be soldered to the ground plane of the board for thermal and RF performance. Vias should be located under the EPAD as shown in the recommended land pattern.

Part Number Ordering Information

Part Number	Reel Size	Devices / Reel
SGL-0622Z	7"	3000

Part Identification

Pin 1 Dot By Marking

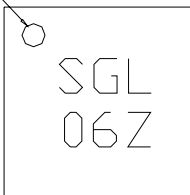

Suggested Pad Layout

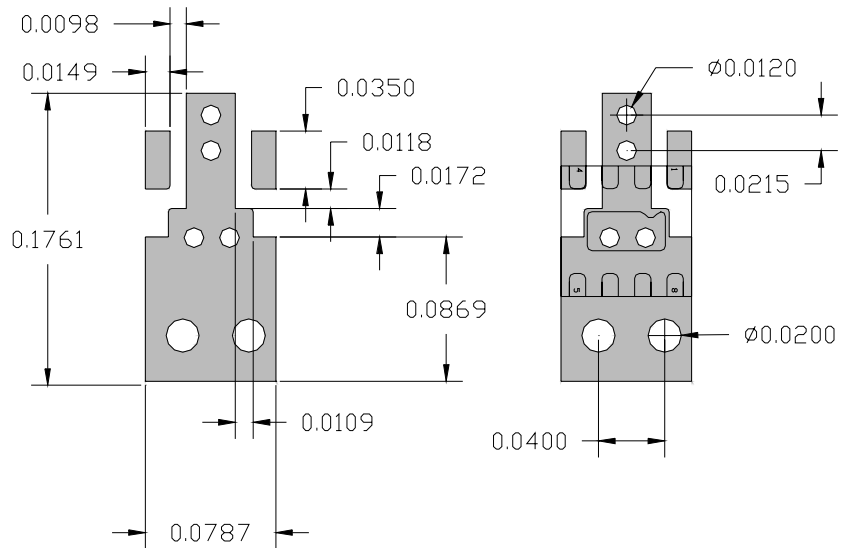

Nominal Package Dimensions

Dimensions in inches [millimeters]

Refer to drawing posted at www.sirenza.com for tolerances.

**Package Type:
2 x 2 QFN**

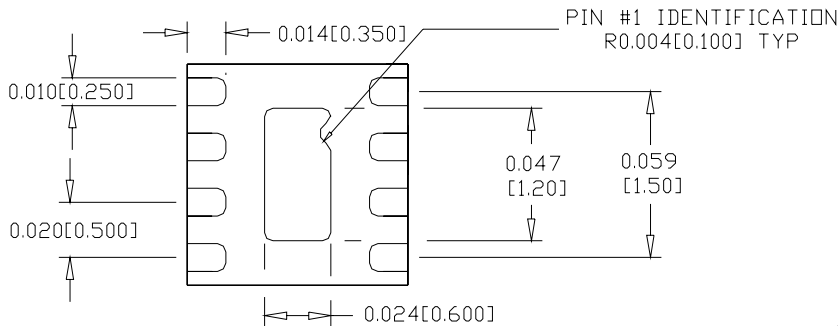

BOTTOM VIEW

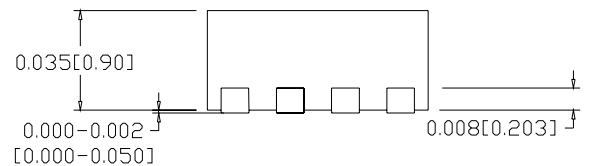

SIDE VIEW